

SUMMARY



Image is for illustrative purpose only

Wires

Low	0
High	0
Coax	1
Triax	0
Quad	0
Fiber	0
Fluidic	0

Download

[Request a quote](#)

[Catalog](#)

Series	00
Termination type	Female solder
IP rating	50
Cable Ø	0.00 - 0.00 mm
Matching parts	FFA.00.250.NTAC29
Status	active
Alternative part	

TECHNICAL DETAILS

Mechanics

Shell Style/Model	ERN*: Fixed receptacle, nut fixing, with earthing tags
Keying	Circular (can rotate)
Housing Material	Brass (nickel plated) shell, collet nut, latch sleeve and mid pieces
Cable Fixing	∅ 0 - 0 mm
Variant	

Performance

Configuration	0.25 : 1 Coax (50 Ohm)
Insulator	T: PTFE
Rated Current	4 Amps

Specifications

Contact Type: Coaxial 50 Ohm (Solder)
Max. Matings: 5000
Contact Dia.: 0.7 mm (0.028in)

LEMO products and services are provided "as is". LEMO makes no warranties or representations with regard to LEMO product & services or use of them, express, implied or statutory, including for accuracy, completeness, or security. The user is fully responsible for his products and applications using LEMO components.

Bucket Dia.: 0.6 mm (0.024in)
 Test voltage: 2.1 kV (rms)
 R (max): 6.1 mOhm
 Vtest: 2100 V (AC), 3000 V (DC)
 □
 Impedance: 50 Ohm
 VSWR: $1.09 + 0.11 * f/\text{GHz}$

Others

Endurance (Shell): 5000 mating cycles
 F ret (min): 100 N
 IP Rating: 50

DRAWINGS

Draws

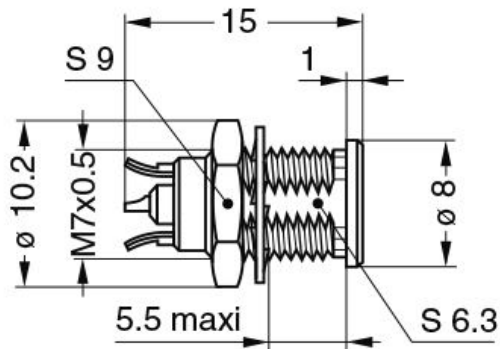

Dimensions

	A	L	Weight
mm.	8	15	2.8
in.	0,31	0,59	0,11







RECOMMENDED BY LEMO

Tools

None

LEMO products and services are provided "as is". LEMO makes no warranties or representations with regard to LEMO product & services or use of them, express, implied or statutory, including for accuracy, completeness, or security. The user is fully responsible for his products and applications using LEMO components.

Cables

CCN.50.051.1529NMC			
017 420	PVC	Black	
017 450	COPOLYMER	Black	
018 000	PTFE	Brown	
018 700	PTFE	White	
018 800	PTFE	White	
031 600	PTFE	Brown	
062 000	PVC	Black	
159 580	PVC	Black	
178 190	PTFE	Brown	
196 270	PTFE	White	
CCX.50.030.083.180B		White	
CCX.50.RG0.58AU14B	FEP	White	
CCX.50.RG1.74-U25N	PVC	Black	
CCX.50.RG1.74AU28N	PVC	Black	
CCX.50.RG1.74AU28N	PVC	Black	
CCX.50.RG1.74U25N	PVC	Black	
CCX.50.RG1.78BU18M	FEP	Brown	
CCX.50.RG1.78BU18M	PTFE	Brown	
CCX.50.RG1.88AU24B	TFE	White	
CCX.50.RG1.88AU26B	PFA	White	
CCX.50.RG1.88AU26B	PTFE	White	
CCX.50.RG1.96AU19B	PTFE	White	
CCX.50.RG1.96AU20B	PFA	White	
CCX.50.RG3.16BU26M	FEP	Brown	
CCX.50.RG3.16U28M	PTFE	Brown	
CCX.75.040.195327G	PVC	Grey	
CCX.75.RG0.59BU62N	PVC	Black	
CCX.75.RG1.79BU26M	FEP	Brown	
CCX.75.RG1.87AU26B	PFA	White	
CCX.75.RG1.87AU27B	PTFE	White	
CCX.93.RG0.62AU62N	PVC	Black	
CCX.95.RG1.80BU36M	PTFE	Brown	
CCX.95.RG1.95AU37B	PFA	White	

LEMO products and services are provided "as is". LEMO makes no warranties or representations with regard to LEMO product & services or use of them, express, implied or statutory, including for accuracy, completeness, or security. The user is fully responsible for his products and applications using LEMO components.